



THE DECOMATIC® TRACK SYSTEM

The word "DECOMATIC" consists of Decorative and Automatic. As a product, it's the first vertical blind system worldwide that was specially designed to be processed on automatic equipment. And, best of all, it is loaded with unique features to give years of trouble free service.

- ◆ Heavy duty self-aligning carrier with clear hook. UV stabilized.
- ◆ Minimal light gaps on the top and side.
- ◆ Slack releaser for convenient window cleaning.
- ◆ 100% equal spaced slope tracks
- ◆ Operational tracks for bow, curved, and arched windows
- ◆ Battery operated remote control for rotation



DECOMATIC SLOPED TRACK



**STANDARD
OPERATING
TRACK**

**VERTICAL BLINDS
DECOMATIC HEAVY-DUTY
REPLACEMENT TRACK**

WIDTH TO	25"	37"	50"	62"	75"	85"	88"	100"	112"	120"	131"	144"	156"	169"	175"	192"
PRICE	65	65	88	109	110	124	130	147	159	171	184	203	222	239	249	272

For Slope Track add \$4.50 per inch to above price, then deduct your discount.

**DECOMATIC
HEAVY-DUTY
VERTICAL
SYSTEM**

DECOMATIC SPECIFICATIONS

General – Heavy-Duty vertical system capable of rotating and traversing at widths up to 240" (300" special order) for residential and commercial applications. The hook replacement feature is provided with Decomatic tracks.

Operation – Available in: • One-Way, • Split Draw, • Center Stack, and • Off-Center Split Draw or Stack.

Specialty Applications – Curve, arch, bow or bay curve, motorized, mono- control, slope (angle) tracks, wand rotations, and top and bottom tracks (wall mounted and skylight).

Headrail – Made of extruded aluminum alloy 6063-T5, 1-1/2" wide by 1" high. The extrusion has a normal wall thickness of .045". The finish will be clear anodized. Painted, bronze, white, or ivory is available for an additional charge. Call Worldwide for pricing.

Tilt-Rod – Made of extruded aluminum alloy 6063-T5, 1/4" diameter, single groove.

Louver Carrier – Each carrier is 5/16" wide with two wheels, molded of self lubricating plastic such as celcon. The carriers have a geared clutch system for overload protection and a steel clutch spring to reinforce positive action. There also is a unique stabilizer bar designed to fit into the extruded slot in the aluminum headrail to provide smooth traversing along the width of the headrail. The hooks of the carrier are made of clear, high ultra-violet resistant polycarbonate and are replaceable even while the unit is installed. The carriers provide the louvers with 185° rotation capability to provide full louver closure and will stay in position unless reset.

The rotation chain is made of celcon beads molded onto a nylon cord of #6 metal chain. One full cycle of the control chain (13-1/2") will self align the louvers.

Spacer Links – The spacers, made of flexible, corrosion proof, stainless steel, are interlocked between carriers to provide smooth traversing. Spacers are 6.03mm x .19mm. Spacing systems are designed for 2", 2-1/2", 3", 3-1/2", 4" and 5" louver widths. Special spacing is available upon request. Spacing is equal on all louver widths.

End Caps – All Decomatic tracks are manufactured with completely covered end caps, concealing internal parts for a custom, finished appearance. The end caps are molded of self lubricating plastic such as celcon and their unique design allows for only 1/4" light gap on the control side of inside mount verticals. The Decomatic system is available with standard direct drive 1-to-1 rotation mechanism (13-1/2" of chain required to rotate 180°), or a 4-to-1 ratio rotation mechanism (46" of chain required to rotate 180°).

Stack – 5/16" wide carrier and 1/4" light gap end cap allows for very tight stacking. 122" on-way draw track stacks in 15" space.



GENERAL VERTICAL BLIND INFORMATION

1. Vertical Blinds are available up to 240" wide.
Divide total width by 2 and price as separate blinds.
2. All Channel Panels are non-yellowing.
3. Opposite Stack/controls, Center Stack, Off Center Draw, Wand Tilt are offered at no additional charge.

REMOTE CONTROL VERTICALS

1. Automated Infrared Tilt Motor is available for \$395.00.
Remote Control not included, add \$120.00.
2. Hard wire with Remote Control or Wall Switch or BOTH are also available. Please call Customer Service for pricing.

BOWS, CURVES AND ARCH TRACKS

1. Operational tracks for Bow, Curved, and Arched windows are available. Please contact Customer Service with your specifications for pricing.
(They Really Work!)

SLOPE VERTICALS

1. Sloped vertical blinds are shipped complete for you. No cutting on the job is required. Specify the length of the slope side, the high side, low side and bottom. The vertical track and PVC will be cut to exact size for a perfect fit, making installation easy.
2. To price sloped vertical blinds, go to the appropriate price grid. Use the sloped track length as the blind's overall *width*, and longest slat as the blind's overall *height* to determine the correct price, add \$3.50 per inch for special slope track, then deduct discount.

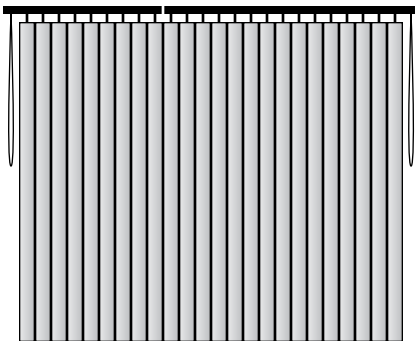

Off-Center Split

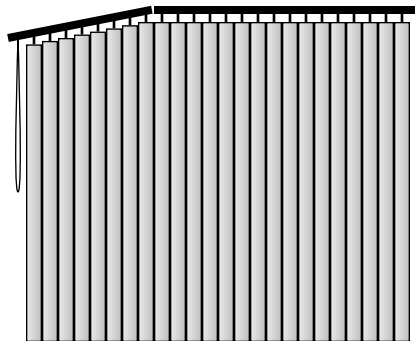

Slope/Regular

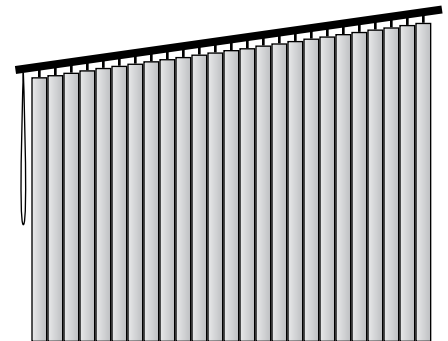

Slope

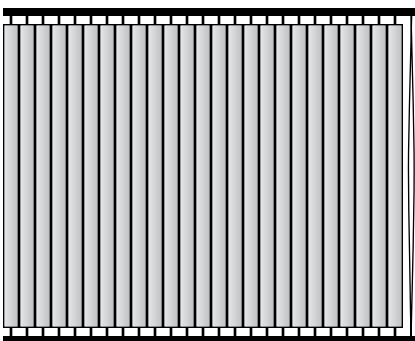

Top & Bottom

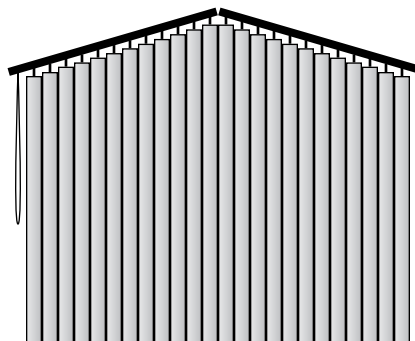

Paired Slope

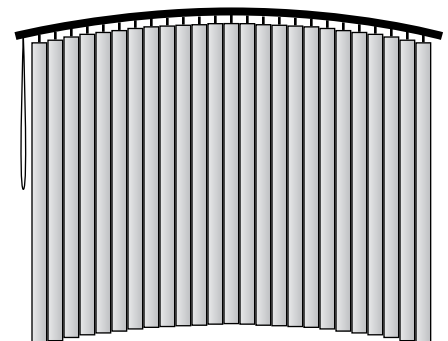

Curved Headrail

DECOMATIC® SLOPE OR ANGLE TRACK SYSTEM

MAXIMUM ANGLE:

55° without cutting corner of louver, 64° with cutting corner of louver.

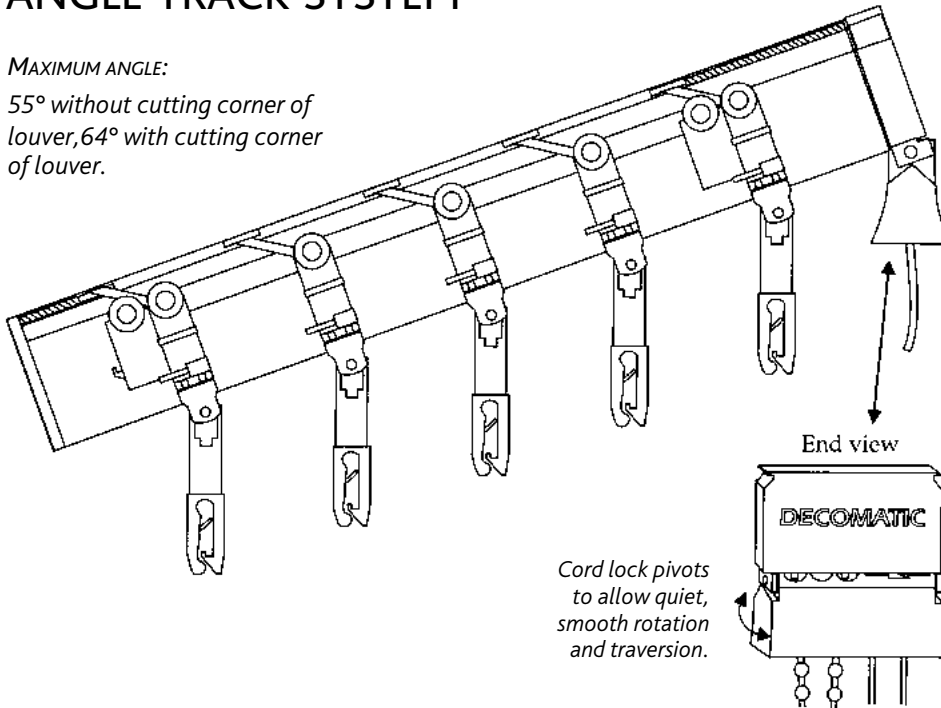

SPECIFICATIONS:

GENERAL - Heavy duty system capable of rotation and traversal at widths up to 240" (40 lb. maximum vane weight).

CONTROLS - Available on the high side or low side.

TRAVERSION - Vanes stack on high side only, one-way draw only.

OPTIONS - Motorization is optional.

END CAPS - Unique cord lock design molded of self lubricating plastic such as celcon. The cord lock feature allows the louvers to be stopped at any point along the incline without the use of a cord tie down cleat.

CARRIER - Carrier housing and gear mechanism are the same as the standard Decomatic.

HOOKS - Hooks are molded of celcon or polycarbonate. Four different size hooks are used (one size per track). The length of the hook is determined by the angle of the track.

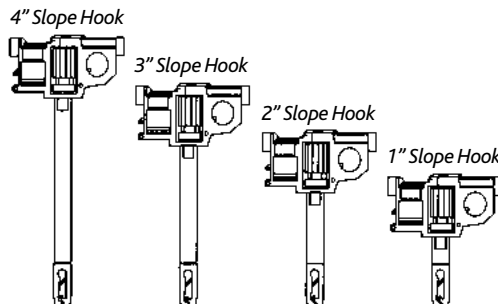

100% EQUAL SPACED SLOPE TRACKS

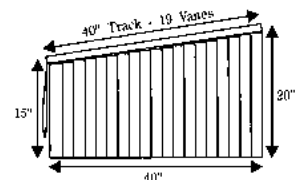
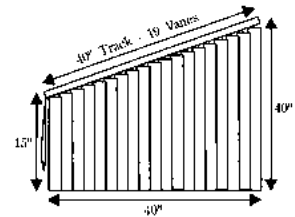
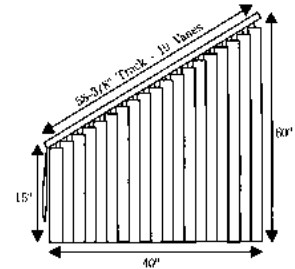
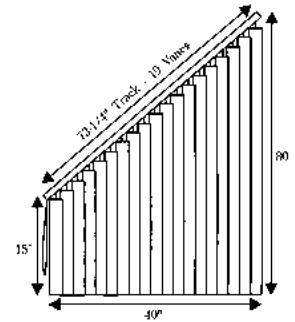

The number of vanes is determined by the bottom width of the window opening and will stay the same regardless of angle or length of track.

NOTE: If a standard unit is mounted directly below slope track and the standard unit is the same width as the bottom width of the slope track, both units will have the same louver count.

DECOMATIC® TRACK SYSTEM VERSATILITY:

Decomatic® Verticals offer a unique variety of features and applications such as sky light verticals, curved track, sloped blinds, as well as standard window applications, all of which may be motorized.

CURVED TRACK

The new Decomatic® curved track is available as both an arched track and radius track. Curved and straight combinations are possible and all curved tracks rotate and traverse completely.

SLOPE TRACK

The Decomatic® slope track is available for angles up to 55 degrees. Sloped and horizontal units can be combined to satisfy odd window configurations. The slope track rotates and traverses completely and has an exclusive cord lock system.

TOP & BOTTOM TRACK

For sky lights, a specially equipped second track holds the louvers in position and contains spring loaded louver hooks to maintain tension. The top and bottom tracks rotate and traverse simultaneously.



DECOMATIC SLOPED TRACK



DECOMATIC CURVED TRACK

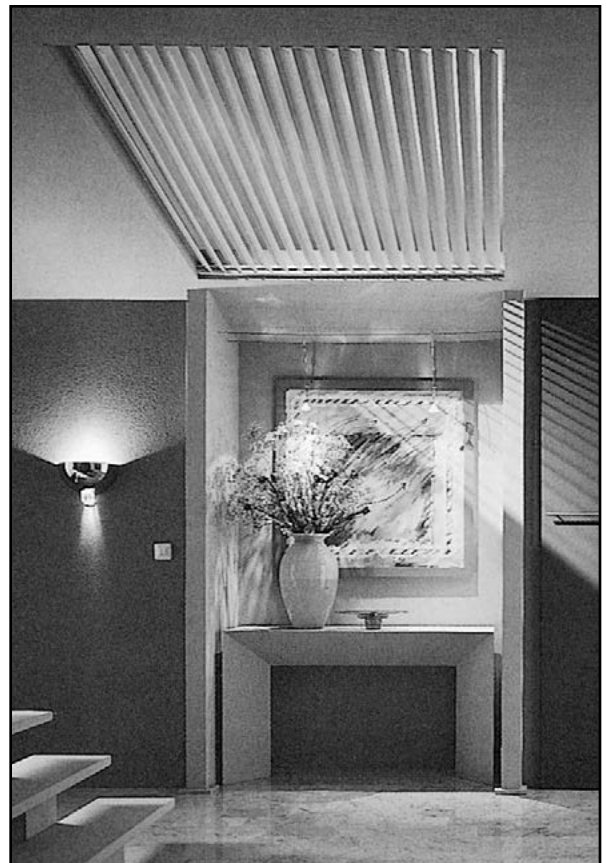

DECOMATIC SKYLIGHT TRACK

DECOMATIC® TRACK SYSTEM FEATURES:

The Decomatic® track is made of premium grade, heat treated aluminum in several finishes. Only the highest quality material such as Hostaform, Makrolon and Hardened Stainless Steel are used to ensure the long term ultra-violet and corrosion stability of the system.

The Decomatic® tracking system utilizes the latest in technology to provide the best available performance in vertical blind systems.

CONTROL OPTIONS:

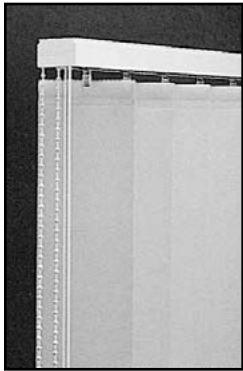

Standard Control



Tilt Wand Control

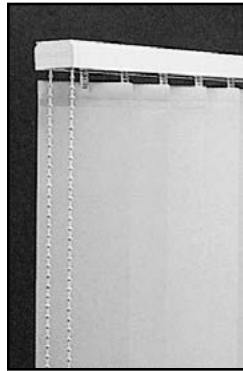

Mono Control

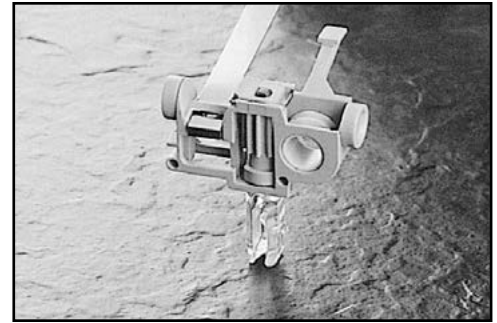

Heavy duty self-aligning carrier with clear hook. UV stabilized.

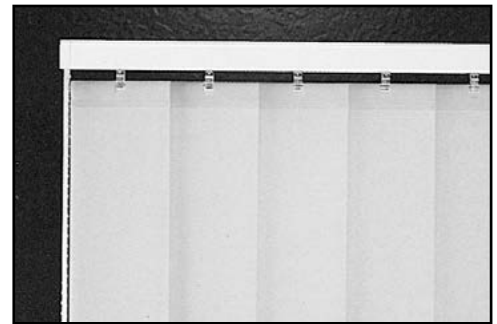

Minimal light gaps on the top and side.

ACCESSORIES:



Neat and sturdy bracket system.

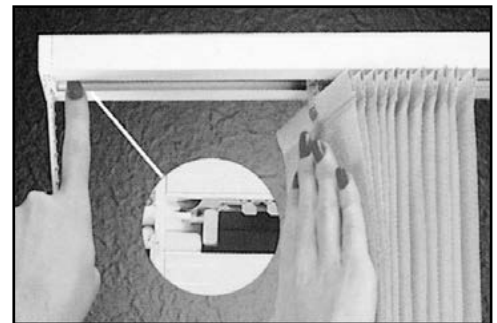

Stack releaser for convenient window cleaning.



LIFETIME GUARANTEE A Limited Warranty

The manufacturer warrants that Decomatic® Track Systems will be free from defects in materials and workmanship for as long as the original retail purchaser owns the product. PROVIDED THAT (i) such products were properly installed in residential dwellings; and (ii) such products were made or assembled exclusively from fabricator materials and components.

The obligation of the Manufacturer and its licensed fabricators and distributors is limited to repair or replacement of the shades or components found to be defective and excludes shipping charges and labor costs for measuring and installation. Repairs will be made with like or similar parts.

To obtain warranty service, contact the Fabricator from whom you purchased the product. The Fabricator will promptly repair or replace any defective parts or components without charge. Warranty claims must be accompanied by proof of purchase, as well as details regarding the nature of the problem, location of the shade, etc.

This warranty does not include any conditions or damages resulting from accidents, alterations, misuse, abuse, motorized devices, or failure to follow our instructions with respect to measurement, installation, cleaning or maintenance. This warranty also does not cover any condition or damage resulting from removal of the shade and reinstallation in the same or another window.

This warranty also does not apply to conditions caused by normal wear and tear upon the product.

THIS WARRANTY IS EXCLUSIVE AND IN LIEU OF ALL OTHER OBLIGATIONS, LIABILITIES, OR WARRANTIES. In no event shall the manufacturer or its licensed fabricators or distributors be liable or responsible for INCIDENTAL OR CONSEQUENTIAL DAMAGES or for any other direct or indirect damage, loss, cost, expense or fee. Some states do not allow the exclusion or limitation of incidental or consequential damages, so this exclusion or limitation may not apply to you.

This warranty gives you specific legal rights, and you may also have other rights which vary from state to state.

